

**Innenansicht**  
 View from the Inside

- ① **erstöffnend** | primary panel
- ② **zweitöffnend** | secondary panel

**I - 3R**

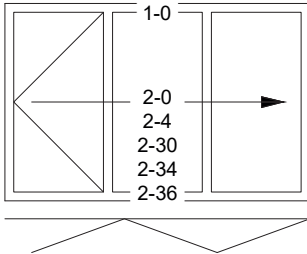

**I - 3R**

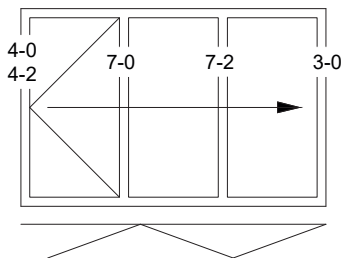

**I - 3L 3R**

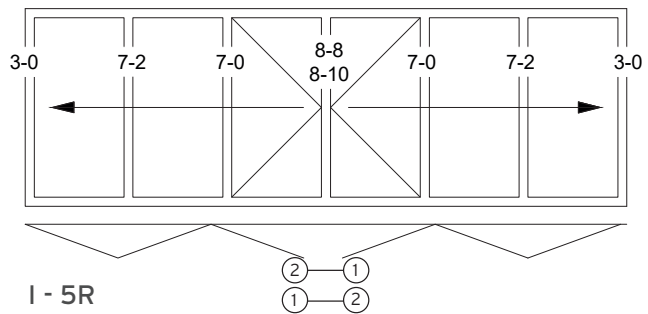

**I - 2L 1R**

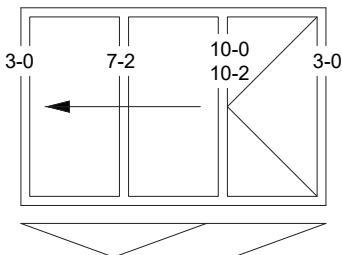

**I - 5R**

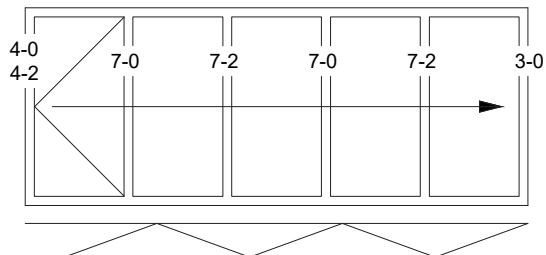

**I - 4R**

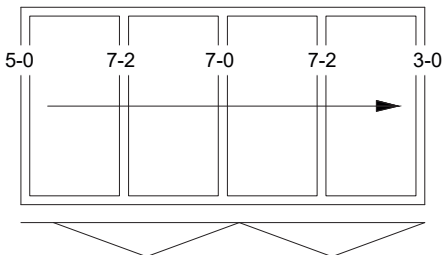

**I - 2L 3R**

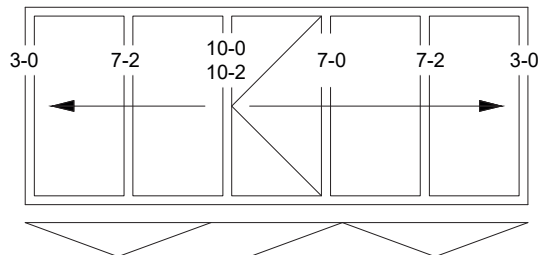

**I - 2L 2R**

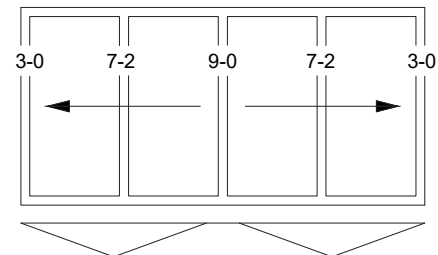

**I - 1L 3R**

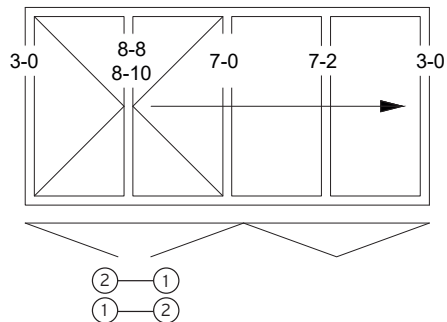

**Innenansicht**  
 View from the Inside

- ① **erstöffnend** | primary panel
- ② **zweitöffnend** | secondary panel

**A - 3R**

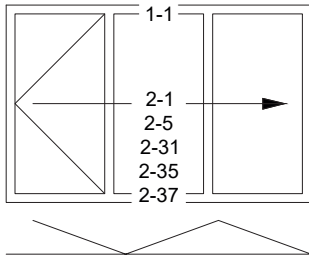

**A - 3R**

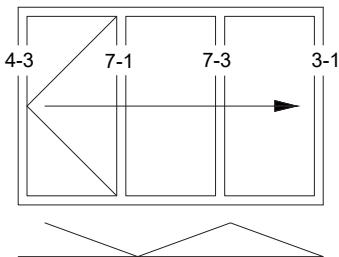

**A - 3L 3R**

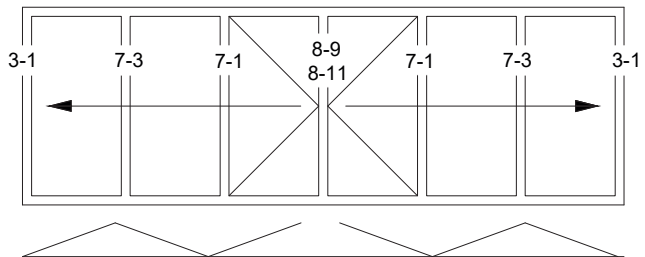

**A - 2L 1R**

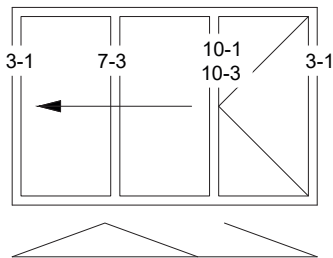

**A - 5R**

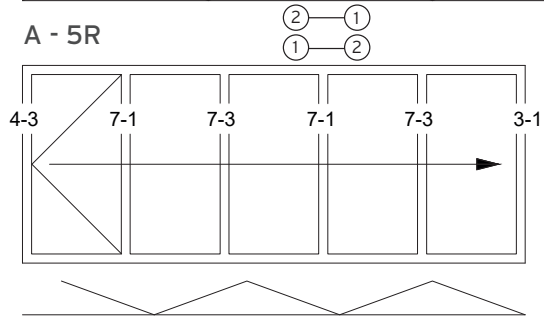

**A - 4R**

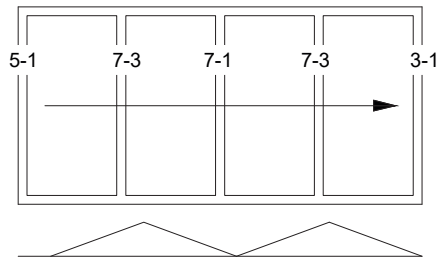

**A - 2L 3R**

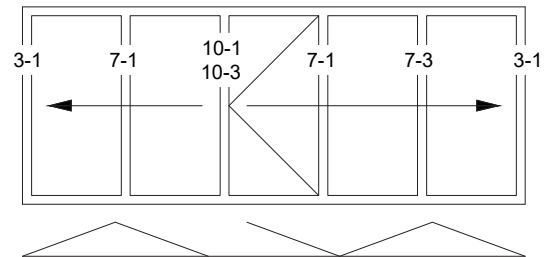

**A - 2L 2R**

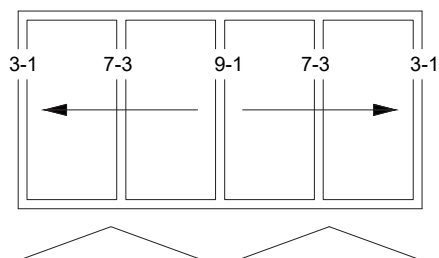

**A - 1L 3R**

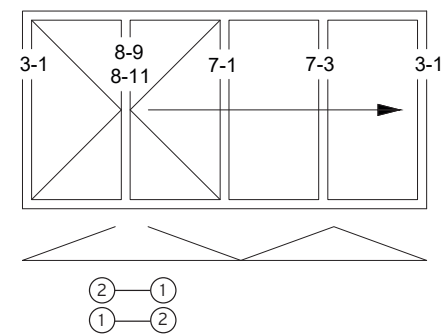

**Innenansicht**  
View from the Inside

Faltwand mit Sprosse  
Folding facade with transom

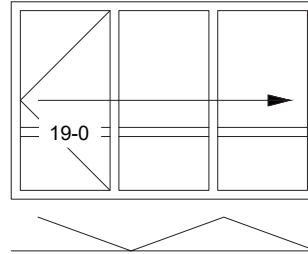
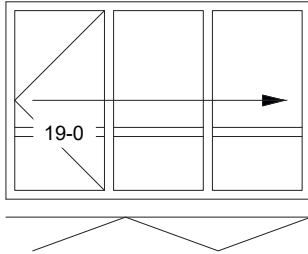

**Innenansicht**  
 View from the Inside

- ① **erstöffnend** | primary panel
- ② **zweitöffnend** | secondary panel

**I - 3R**

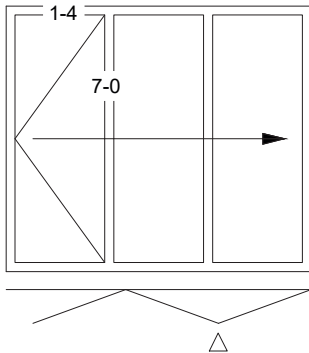

**I - 4R**

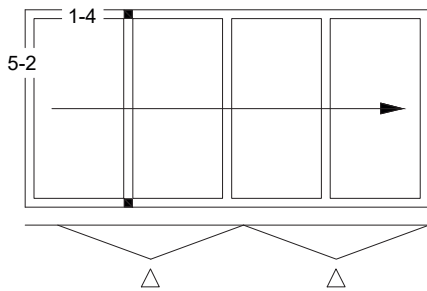

**I - 2L 2R**

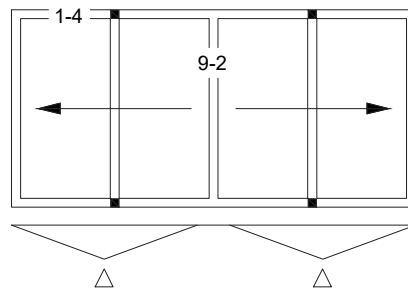

**I - 2L 1R**

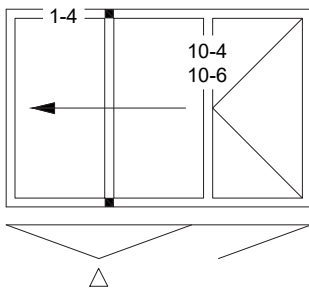

**I - 2L 3R**

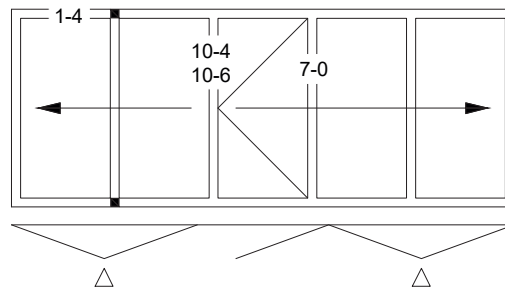

**I - 3L 3R**

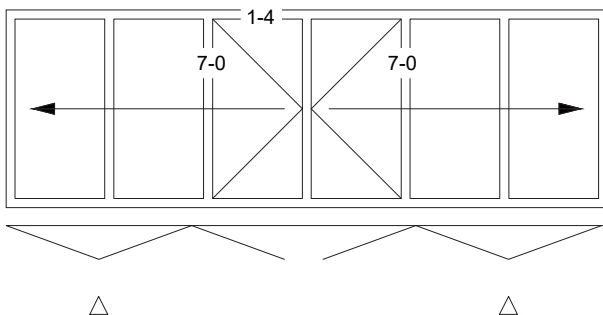

**Hinweis:** Putzbeschlag ist nur bei innen öffnenden Anlagen mit Fangbeschlag möglich.

**Please note:** The cleaning fitting is only useable for inside opening units with upper retainer fitting

■ = fixer Verriegelungspunkt | cleaning fitting

△ = Putzbeschlag | fixed locking point

**Innenansicht**  
 View from the Inside

- ① **erstöffnend** | primary panel
- ② **zweitöffnend** | secondary panel

**I - 4LR**

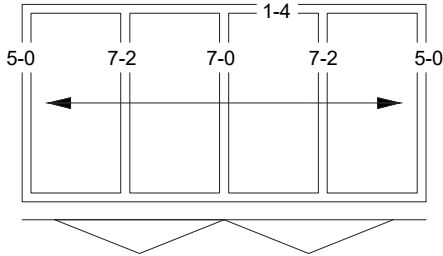

**A - 4LR**

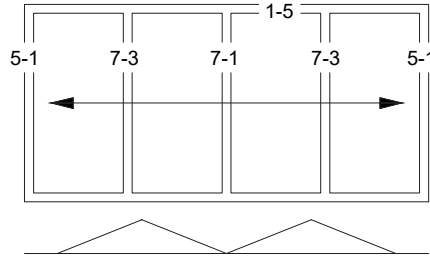

**I - 2LR 2LR**

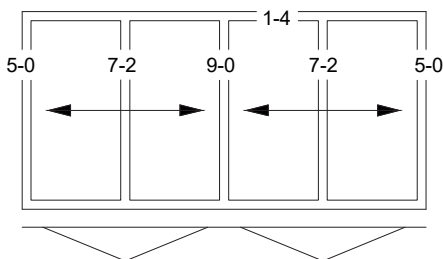

**A - 2LR 2LR**

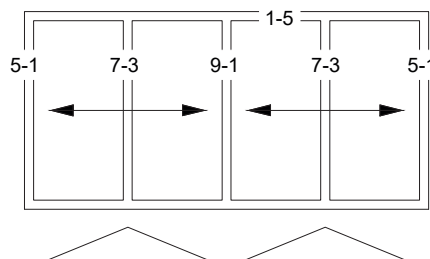

**I - 2LR 3R**

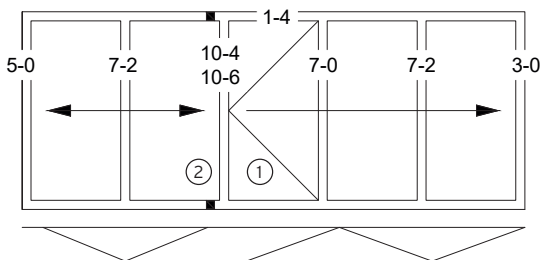

**A - 2LR 3R**

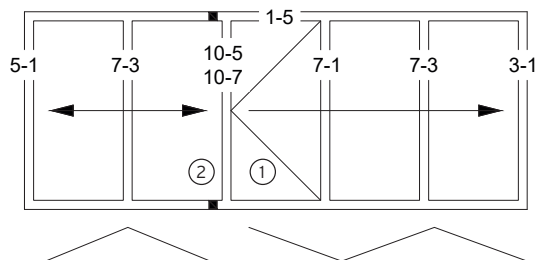

**I - 1L 3LR Dreh · I - 1L 3LR swing**

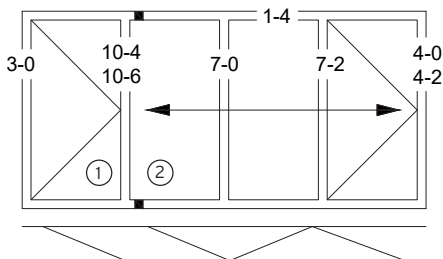

**A - 1L 3LR Dreh · A - 1L 3LR swing**

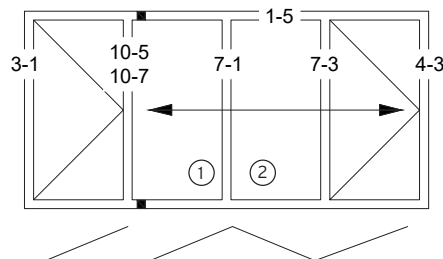

**I - 1L 4LR Dreh · I - 1L 4LR swing**

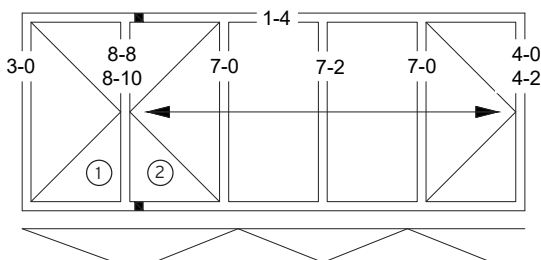

**A - 1L 4LR Dreh · A - 1L 4LR swing**

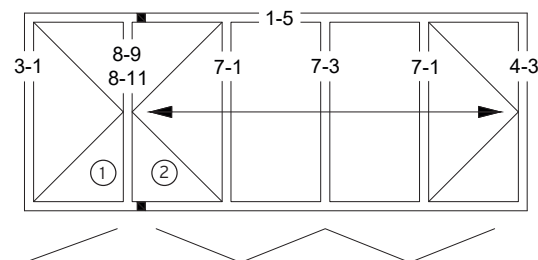

■ = fixer Verriegelungspunkt | cleaning fitting